

User Guide

# Blowout Attachment

---



## Product Information Specification

Item	Product Code
Blowout Attachment	ZZ120206

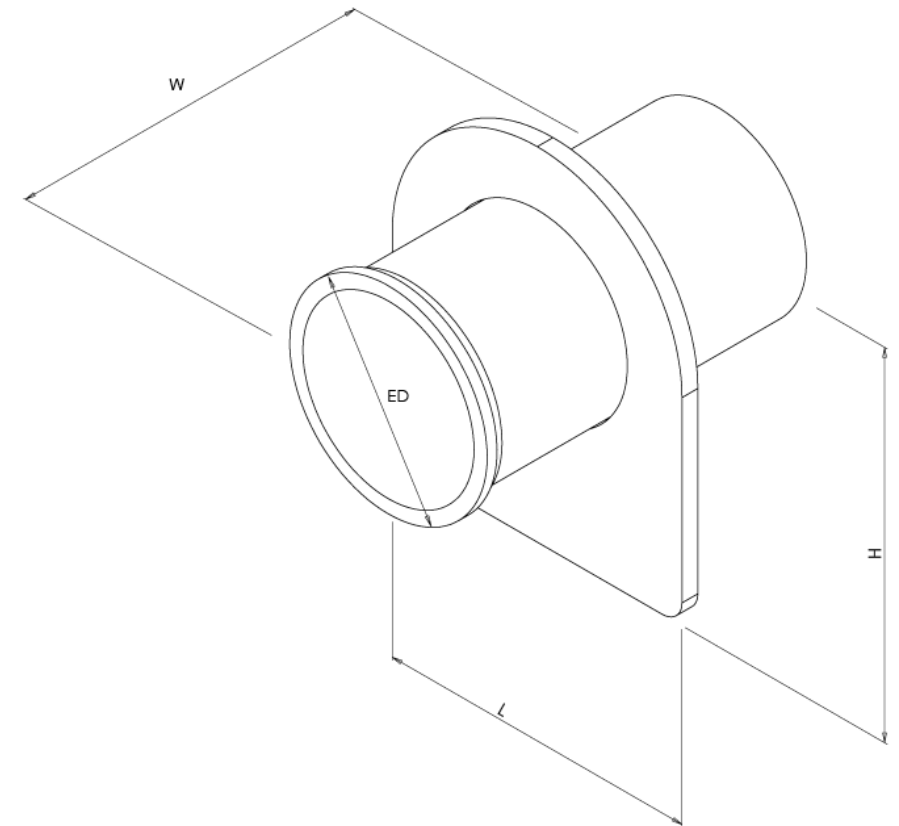

<sup>1</sup>Working Load Limit

Height	Width	Length	Weight	External Diameter
260mm	250mm	220mm	6kg	148mm

## Product Information Overview

The Conquip Blowout Attachment is a safe, simple way of facilitating blowout of concrete pump lines into a concrete column skip. Enabling blowout directly to a skip allows the contractor to use the concrete in the pump line to complete the pour rather than letting it go to waste.

### Key Benefits

- Safe, simple way to blowout concrete pump lines, specifically a concrete placing boom.
- Blowout into a skip means that no concrete should be wasted.
- Easily retrofitted to an existing Conquip Column Skip or available as a customisation on a new product. The Column Skip can still be used for its original uses.
- The attachment means that a concrete pump line can also be cleaned through directly into the concrete washout system and the waste water can be reused.

**Blowout Attachment**

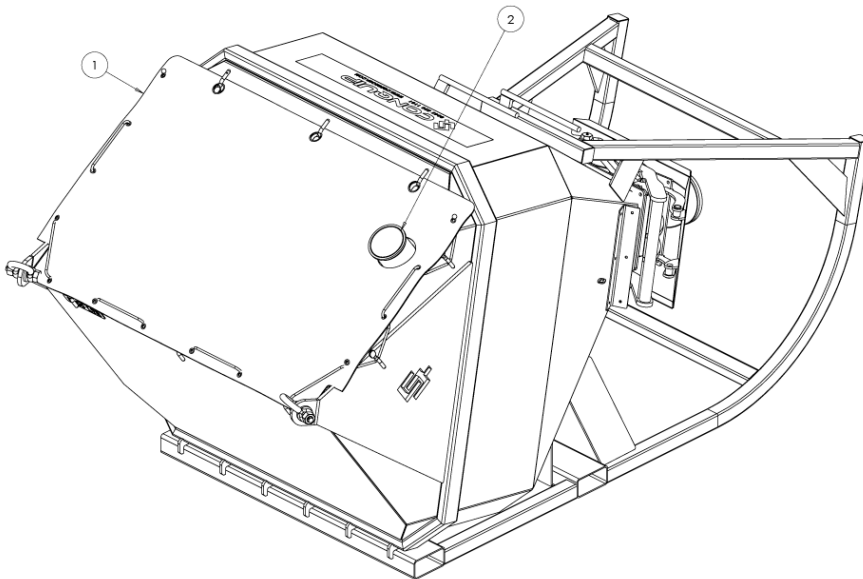

NOTE: These parts are for this model, they may differ for previous versions. Please contact Conquip with any queries.

Item Number	Part Number	Description	Quantity
	NE402-02000	Column Skip Cover for 2000 litre Skip	1
1	NE403-02000	Column Skip Cover for 3000 litre Skip	1
	NE404-02000	Column Skip Cover for 4000 litre Skip	1
2	ZZ120206	Blowout Attachment	1

**Important Usage Notes**

- If the Blowout Attachment is to be retrofitted to a Conquip column skip, it must be carried out by an engineer, who is an employee of Conquip, unless full written approval has been gained from Conquip Engineering Group prior to the work being carried out.
- There may be more concrete in the line than the skip can take. Follow safe usage instructions of the concrete pump to ensure that the line is blown through steadily and does not discharge more concrete than the skip can take. Refer to the separate Conquip column skip user guide for the Working Load Limit and capacity of the individual skip.
- Before using the concrete pump, refer to the manufacturers safety and usage instructions for best practice use. These instructions for 'blowout' are only a guide.

**Installation Instructions**

1. Fit the Conquip skip cover over the 'mouth' of the column skip, the hole in the cover must line up and fit over the Blowout Attachment. Ensure that the tube from the Blowout Attachment can protrude through the cover.
2. Make sure the elasticated cord is tightly secured to the hooks on all sides of the Column Skip. This is done by stretching the cord down under the hook as you let go the cord should tension.
3. Guide the concrete pump placing boom to the concrete Blowout Attachment and clamp it to the circular ring on the outside of the skip.
4. Following safe usage instructions of the pump, blow the concrete pump line through and discharge remaining concrete into the skip.
5. Disconnect the placing boom, take off the cover and remove the bung ('pig') from the skip before using the concrete.
6. Crane lift the skip onto a skip washing platform, refit the concrete skip cover and reattach the concrete pump placing boom.
7. Clean the concrete pump line with water, or using the best practice method suggested by the concrete pump manufacturer.
8. When cleaning of the pump line is complete, the cover can be removed and the skip and the Conquip Blowout Attachment must be cleaned and concrete removed.

# Original Working Instructions

## Safety Instructions

### Basic Safety

A site-specific Risk Assessment, and lift plan where applicable, must be completed by the responsible person before using this equipment to control risks, produce a safe system of work and ensure safety for you, your colleagues and others. Your risk assessment will determine the correct Personal Protective Equipment (PPE) for the task you are doing. You must use it. Conquip recommends that you should wear:

- Suitable clothing
- Gloves
- Hard hat
- Protective footwear (steel toecaps)
- Safety glasses



### Important Safety Notes

- Read these instructions before using this equipment. If there is anything you do not understand or if you have any concerns do not use this equipment. Contact your supervisor or Conquip Engineering Group for advice.
- You must check that you have considered all the safety requirements for the task you are doing and that this equipment is suitable.
- You must protect bystanders and the general public by preventing access to the working area.
- Do not use this equipment if you are tired, unwell or under the influence of alcohol or drugs. If you are taking any medicine or undergoing treatment you should inform your supervisor.

### Usage & Transportation

- Never unevenly load this equipment.
- The weight of the equipment, together with its attachments, must be added to the weight of the load when calculating the total load that will be imposed on the lifting apparatus / operating machine.
- This equipment must be used in conjunction with the load ratings of the lifting apparatus / operating machine. (Refer to the manufacturers' load ratings and original working instructions).
- Make sure you know how to use this equipment and understand all aspects of its operation in case of emergency.
- This equipment weighs more than 25kg. Do not lift or manhandle without machine assistance.
- Do not operate this equipment near overhead power lines.
- Take care in confined spaces, near ceilings or similar hazards. This equipment was designed for vertical lifting. Do not drag, or swing.
- Before operating this equipment, check that you have enough space for you to work safely and make sure that the working area is clear of hazards, obstructions and personnel.
- Before lowering equipment make sure that the landing zone is clear and capable of accepting the size and weight of the load.
- Crush Risk. Keep hands and feet clear of the equipment at all times to avoid injury.
- Do not exceed the maximum Working Load Limit (WLL) shown on the serial plate. Ensure that the WLL on the individual lift points is not exceeded.
- Before lifting, check that the load is secured, balanced and stable. Allow space for the equipment to move if the load shifts.
- Manoeuvre loaded or raised equipment carefully. Travel and turn slowly to avoid unit becoming unstable.

### Personnel

- All personnel must wear relevant personal protective equipment.
- Do not wear loose clothing or jewellery and tie back long hair to avoid becoming tangled or trapped in this equipment. You must make everyone in the work area aware of what you are doing.
- All personnel involved in the lifting operation must be competent to do so and must have been briefed in conjunction with this User Guide available from Conquip Engineering Group, the manufacturer.

### Equipment Maintenance & Cleaning

- It is mandatory that the equipment is thoroughly examined regularly, by a qualified engineer, to ensure compliance with relevant regulation/s. (Conquip recommend to carry out thorough examination every six months).
- This product may incorporate various loose and detachable items of lifting gear. Refer to the separate requirements for the safe use of those items.
- When not being used, store the unit in a clean, upright condition and in a safe place where it will be protected from thieves and unauthorised users.
- This equipment must be inspected by the responsible person before each use and then regularly, as determined by your risk assessment or working practice. If you have any concerns about condition or suitability do not use.

# Disclaimer

---

## Warranty

The products supplied by Conquip Engineering Group are all guaranteed by a 12 month warranty.

Apart from where exceptions apply, Conquip Engineering Group promises to repair or replace any fault which the Company considers to be due to defective material or workmanship within 12 months of the date of sale, at no additional cost.

- Faults arising from unauthorised alterations (see modifications section below for full details).
- Damage caused by abuse, neglect, misuse or falling.
- Damage caused because of failure to follow transportation, storage, loading, cleaning or operating instructions.
- Replacement or repair of components due to fair wear and tear.
- Any consequential damage or wear arising from the use or fitting of additional or non-standard parts.

## Modifications

If any third-party modifications or alterations, involving drilling, welding, cutting or distortion of materials in any form, are to be carried out on the product, Conquip Engineering Group must provide full written approval prior to the work being carried out.

Alterations, modifications, additions or repairs must be carried out by Conquip Engineering Group's recognised distributors, if they are not carrying out the work themselves.

Conquip Engineering Group operate a continuous improvement policy and therefore reserve the right to alter technical specifications and user guide details at any point without notice.

Conquip Engineering Group will not cover or reimburse any transportation and/or shipment costs to and from their premises or their recognised agents, or any material and/or labour costs for repair, replacement or assessment against a warranty claim.

Conquip Engineering Group and/or their directors, employees, insurers or recognised agents will not be held liable for consequential damages, losses or expenses relating to the inability to use the product correctly for its purpose.

# EC Declaration of Conformity

---

## In accordance with EN ISO 17050-1:2004

Declaration: As defined by the Machinery Directive 2006/42/EC and subsequent amendments

We, CONQUIP ENGINEERING GROUP, herewith declare that the following indicated equipment meets the fundamental health and safety requirements concerning the EU guide line(s), due to their design and manufacture.

This declaration will be rendered null and void if the machine is changed without our approval.

**Signed:**



**Dated: 2018**

**Garry Critchley, Managing Director**

<b>Product Code(s):</b>	ZZ120206
<b>EC Directive/ Regulation:</b>	2006/42/EC, Lifting Operations and Lifting Equipment Regulations 1998 Provision and Use of Work Equipment Regulations 1998
<b>Harmonised Standards:</b>	BS EN ISO 12100:2010
<b>General Description/ Designation:</b>	Blowout Attachment – ZZ120206
<b>WLL:</b>	ZZ120206 = N/A

## Important Notes

- This User Guide is for this Conquip product only.
- Any movements of the product must be thoroughly planned before the work commences to identify potential hazards and assess risk.
- All personnel involved in lifting and transportation of this product must have read this User Guide and must be properly briefed.
- You must be competent, alert and medically fit when using this equipment. If you have a medical condition, a mental or physical disability, you must seek advice from a medical professional before using this equipment.

Talking to us is easy

**We're here to help**

Call us on 0845 520 1101

Email us at [sales@cqegroup.com](mailto:sales@cqegroup.com)

[www.cqegroup.com](http://www.cqegroup.com)

**Conquip Engineering Group**

Waterbrook Estate, Alton, Hampshire, GU34 2UD